



Exercise: DRC

Prof. Dr. P. Fischer

Lehrstuhl für Schaltungstechnik und Simulation
Uni Heidelberg



SOME REMINDERS



Reminders

- When *gravity mode* is on, the cursor snaps to various shapes.
 - Toggle gravity mode with 'g' (Options → Editor...)
 - Better turn it off...

- Toggle between *full* and *partial selection* mode with F4

- Snap mode:
 - Normal is '*orthogonal*': edges can be only in x- or y directions
 - To change, invoke the options menu with F3 when drawing or moving

- Snap grid
 - Change snap grid spacing in editor options ('e')
 - Use as coarse grid as possible. Min = 0.01 μm (in this techno.)



Reminder: Shapes / Contacts / Vias

- Shapes are
 - Paths ('p')
 - Rectangles ('r')
 - Polygons ('Shift-P')

- To create a contact or via, use Create → Vias ('o')
 - Select the layer pair you need
 - it contains shapes on 3 layers automatically

 - You can also create larger arrays
 - In 'stack' mode, you can connect across several layers (for instance M1 → M4)



Measuring Distances with the Ruler

- The ruler can be displayed with Tools → Create Ruler ('k')
- Invoke the option menu with F3 (sometimes twice)
 - Better switch off all snap options
- Rulers are kept with the 'Keep Ruler' option
- Clear all rulers with 'Shift-K'

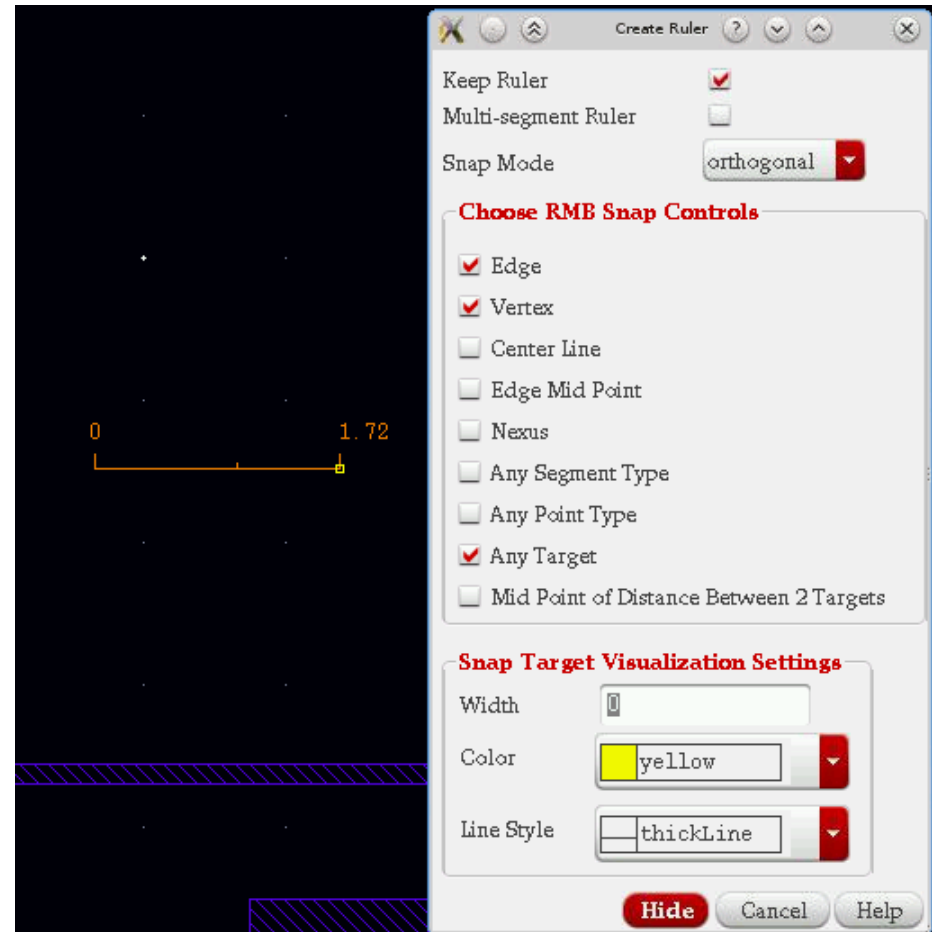



DRC



DRC Design Rule Check

- The Design Rule Check verifies that the geometric rules are respected.
- The rules are specified in a text file



Starting the DRC

- Select from the top menu Assura → Run DRC
 - Make sure *Rule Set DRC* is selected
 - Make sure you have set a run name
 - *OK* closes the window, *APPLY* keeps it

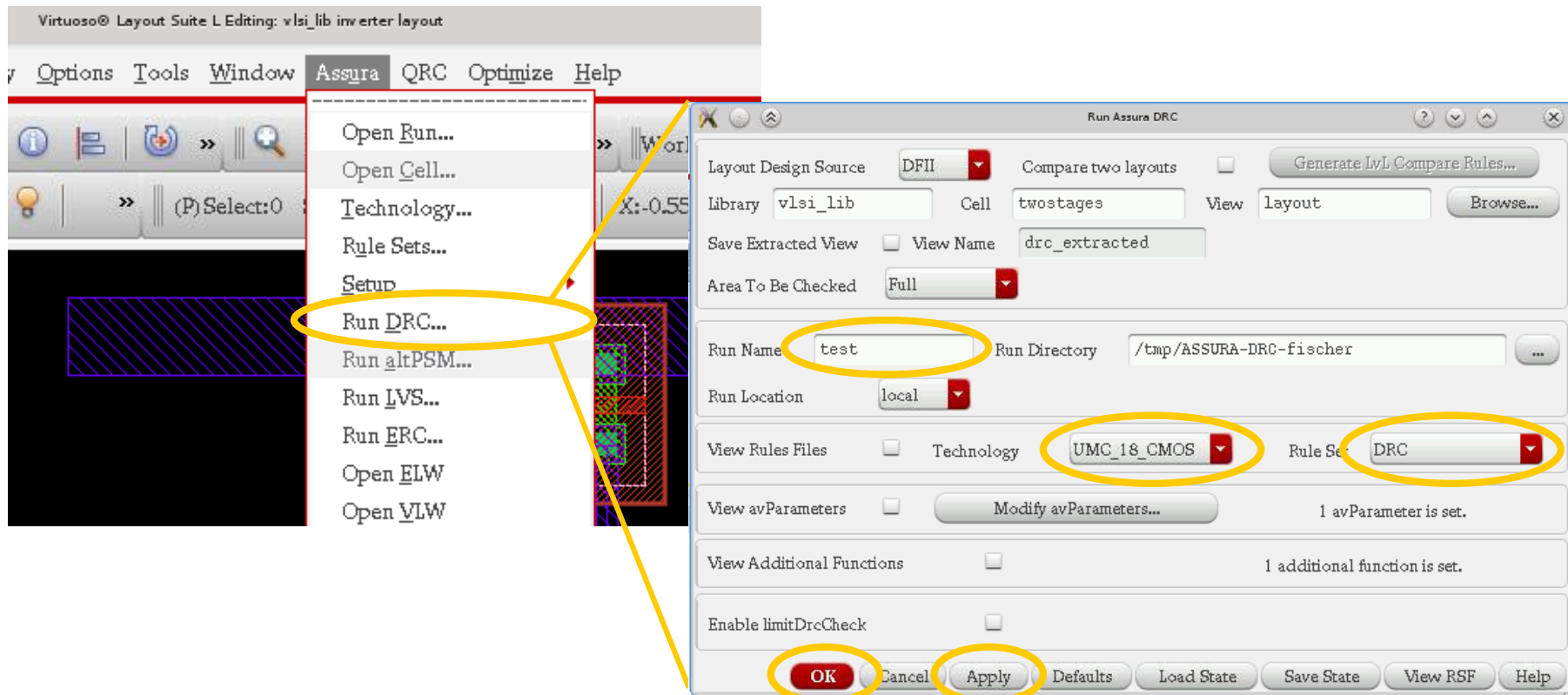



Viewing DRC results

- The Error Layer Window (ELW)
 - Select an errors type (left)
 - The arrow on the right skip from error to error. They are highlighted and zoomed in the layout editor

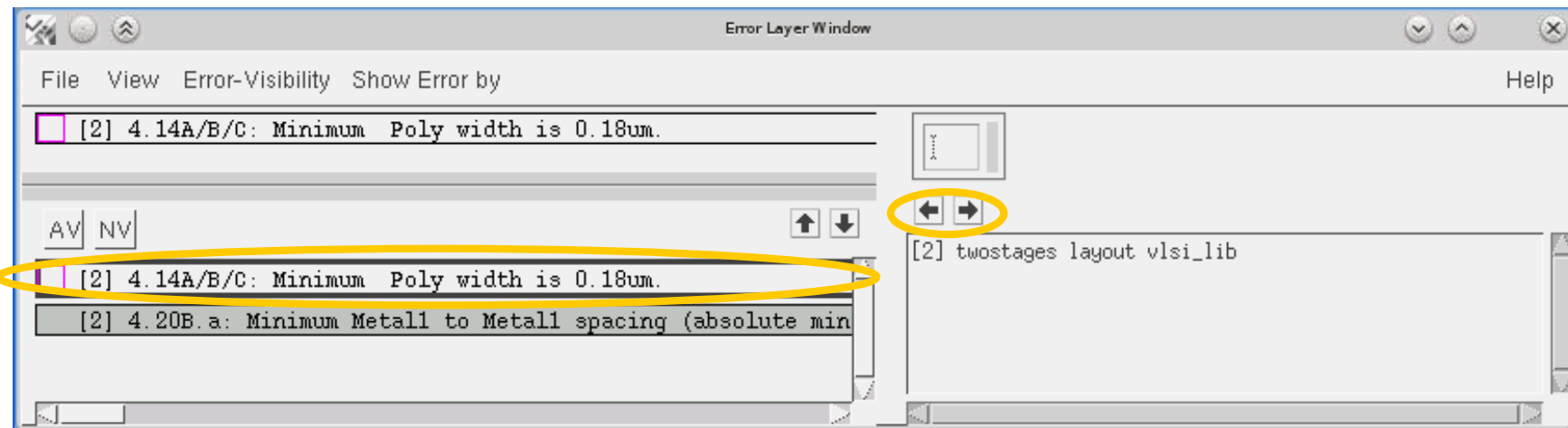
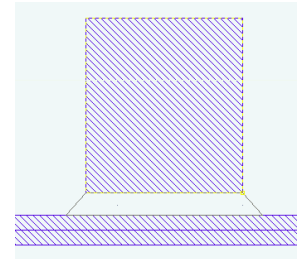

- The ELW cannot be closed with the  button (bug!)
 - Use File → Close ELW



Re-loading a DRC

- If the ELW has been closed, it can be re-opened with
 - Assura → Open ELW

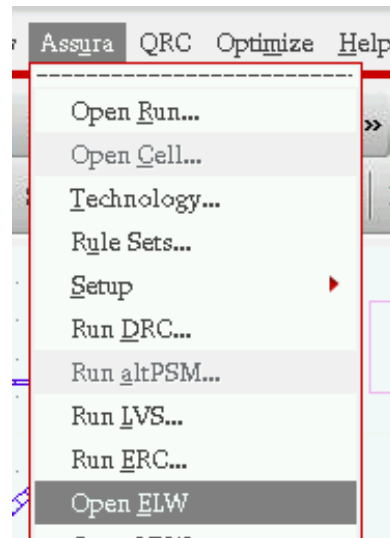

- The run can be closed explicitly in the same menu
- An old run can also be opened there.



Advanced: DRC Options

- You can set specific DRC options
 - Check the 'View Rules File' box
 - Select 'Set Switches'
 - Chose from the options

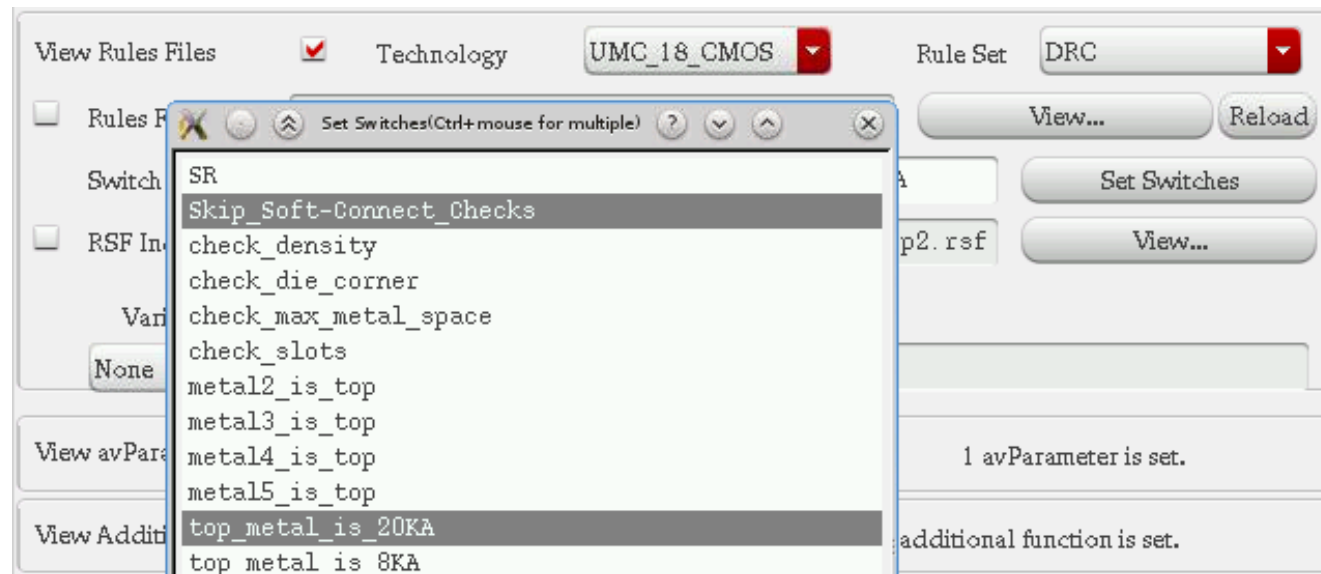

- We use mostly a thick top metal technology ('20kAngström')
- The check_xxx options are only used at the end of the design process...



EXERCISES



Exercise A

- Get a N_18_MM NMOS with minimal size (240nm/180nm) from the library
- Flatten the instance (Chose Edit → Hierarchy → Flatten, make sure you allow flattening of PCELLs)
- Try to make the layout smaller at various places and observe the DRC errors you will get.

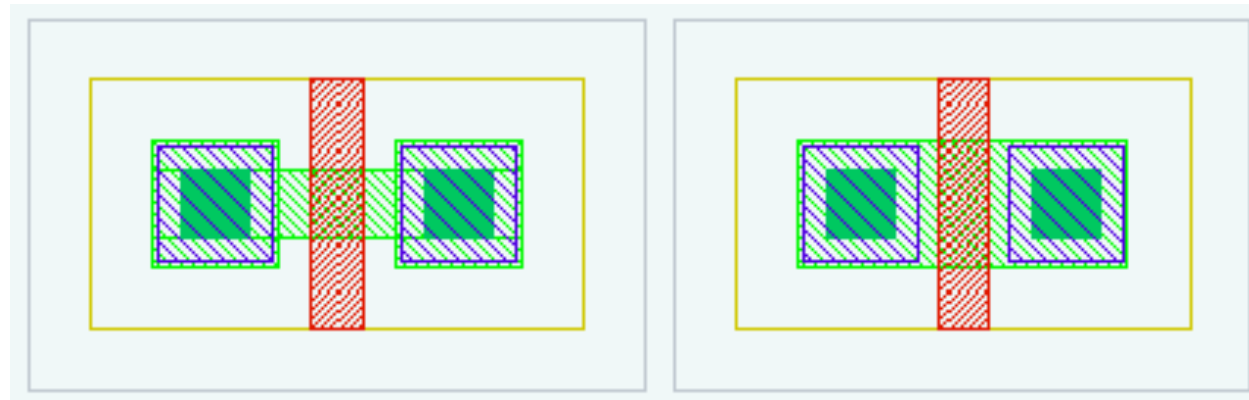

- Increase the width of the MOS to $0.44\mu\text{m}$ and try to make it 'shorter'



Exercise A

- Some important design rules are shown here
- Determine the value from the DRC violations you get

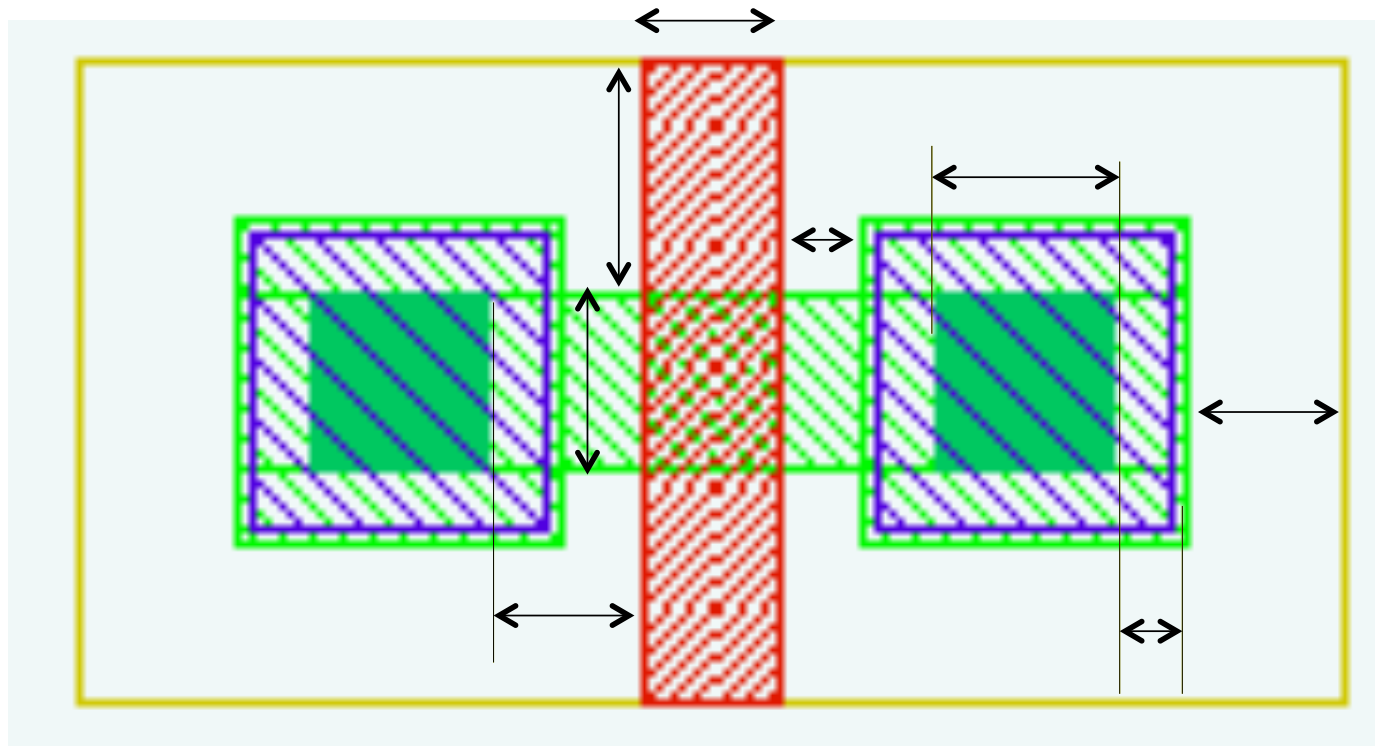



Exercise B

- Make the layout of the parallel connection of two cascoded NMOS transistors:

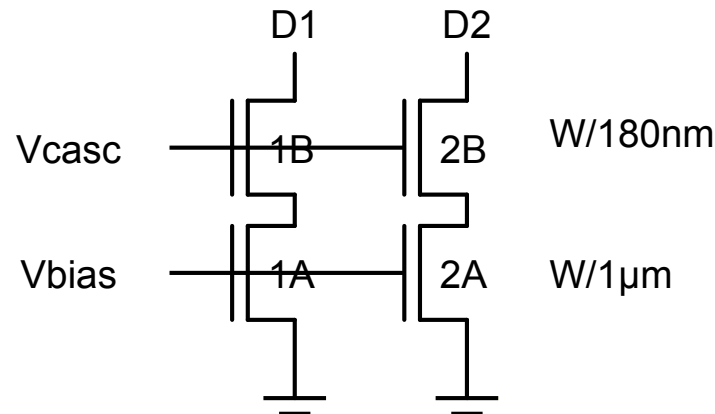

- Not the given lengths! Use $W=500\text{nm}$ to start with
- You can start with a library MOS, flatten it, and change it.
 - Make sure you have SYMBOL/MM layer turned on
- Eliminate the contacts between the series devices A and B
- What is the minimal distance between left and right devices?
- What is the minimal W such that exactly 3 contacts fit into the source?